







13 800 811



- Ausladung 160 mm
- starrer Auslauf
- rechteckiger luftangereicherter Strahl
- Bohrungsdurchmesser 37 mm
- Anschluss 1/2"
- Durchfluss max. 4,5 l/min
- bleifrei
- Dieses Produkt leistet einen Beitrag zur Erfüllung der Vorgaben von nachhaltigen Gebäudezertifizierungen, z.B. LEED®, BREEAM®, DGNB

	Platin / Platin gebürstet	13 800 811-36
	Chrom	13 800 811-00
	Platin gebürstet	13 800 811-06
	Dark Chrome	13 800 811-19
	Messing gebürstet (23kt Gold)	13 800 811-28
	Messing / Messing gebürstet (23kt Gold)	13 800 811-38
	Dark Platin gebürstet	13 800 811-99

Empfohlenes Zubehör



UP-Wandwinkel -

35 085 970 90

- Max. Einbautiefe 163 mm
- Min. Einbautiefe 90 mm

13 800 811

mm [inches]

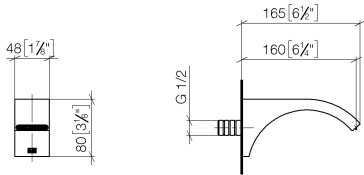

Durchflussdiagramm

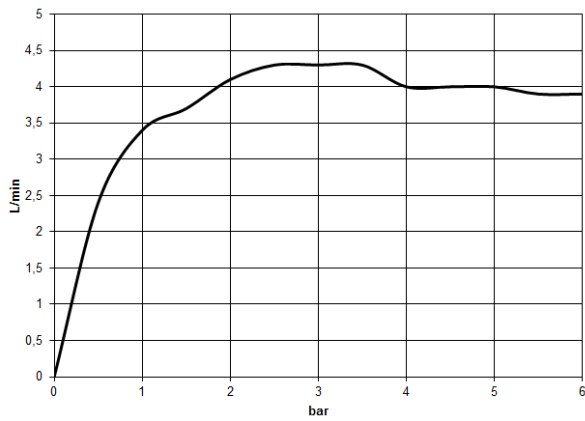

Codes & Standards

DIN 4109

ISO 3822

NSF372

NSF61

Ü-Zeichen



CYO Waschtisch-Wand-Auslauf ohne Ablaufgarnitur - Platin / Platin gebürstet

CYO

13 800 811

Zertifikate

IAPMO_N-4

IAPMO_6

LGA_38

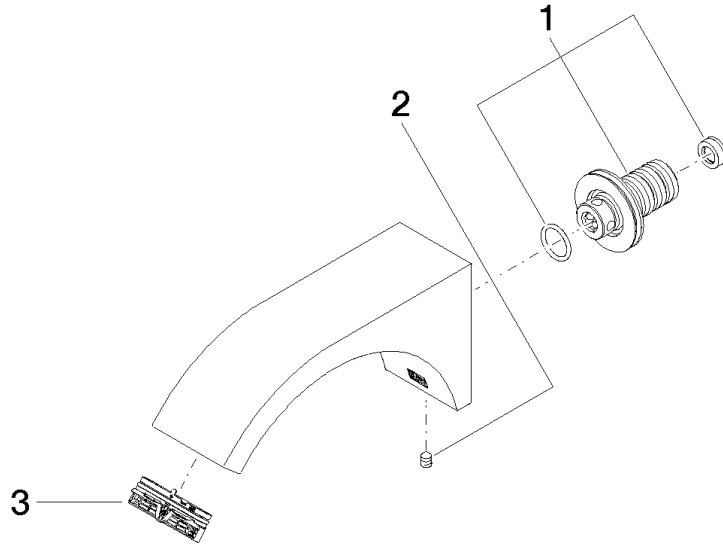



CYO Waschtisch-Wand-Auslauf ohne Ablaufgarnitur - Platin / Platin gebürstet

CYO

13 800 811

Ersatzteilstückliste

Nr.	Artikelnummer	Benennung	Verbaumenge	Lieferzeit
	90 24 03 108 01 90	Nippel Ø 40 x 50 mm, 4,54 l/min. -	3	2