

Technische Daten/ Technical Data

KLUDI-A-QA
wall supply with shower holder
DN 15

Ref.: 65569N2-00

Finishes:
N2 Brushed Gunmetal PVD

Product description
Manufacturer KLUDI GmbH & Co. KG
Typ: KLUDI-A-QA
wall supply with shower holder
Ref.: 65569N2-00

wall supply with shower holder
connection G1/2
for shower hoses with conical nuts
with fixing material
for rigid wall mounting
protected against back flow
with push-on rosette

Produktabbildung/ Product picture

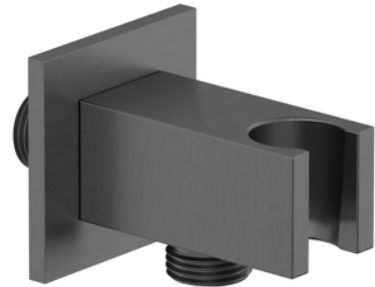

Maßzeichnung/ Dimensional drawing

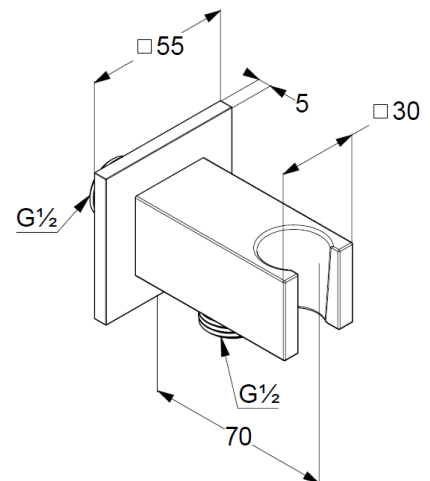

Durchfluss/ Flow rate