

L-Cube

LC 7653

Montageanleitung

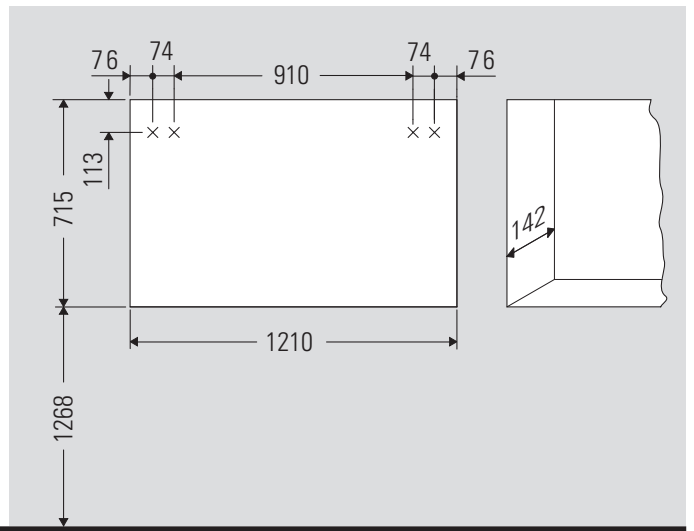
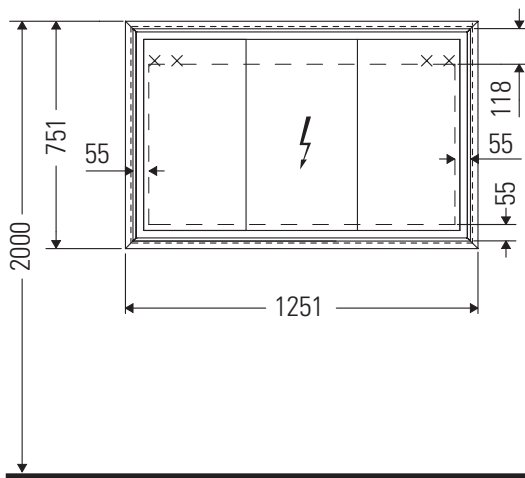

Ausschnittgröße für Einbauschränke

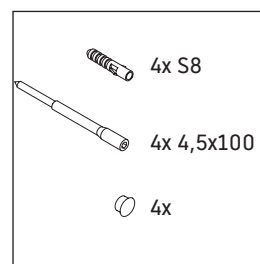
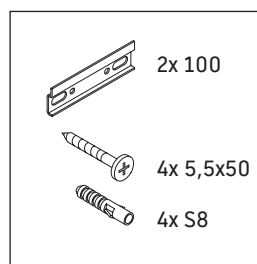
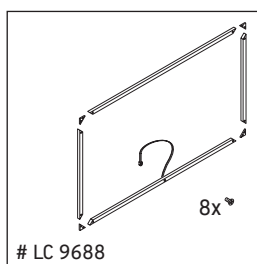
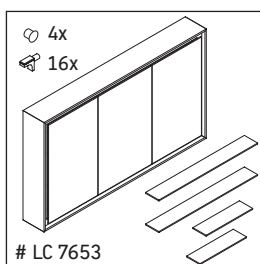

Montageanleitung für Badmöbel mit Stromführung beachten.

Verwendungshinweise

Die Badmöbelserie entspricht den gültigen Normen und Richtlinien zum Zeitpunkt der Auslieferung und ist für den Einsatz in Bädern konzipiert.

Eine direkte Benetzung mit Wasser z. B. beim Duschen ist zu vermeiden.

Stromanschluss 110 V – 230 V muss bauseits vorhanden sein.

Technische Verbesserungen und optische Veränderungen an den abgebildeten Produkten behalten wir uns vor.



LC 9688

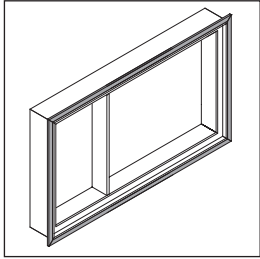

1 # LC 9688

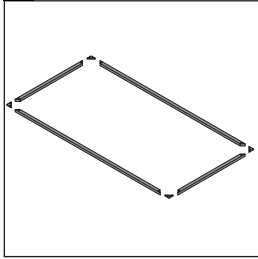

2 # LC 9688

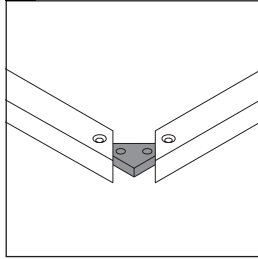

3 # LC 9688

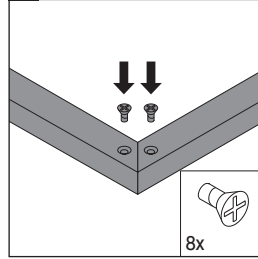

4

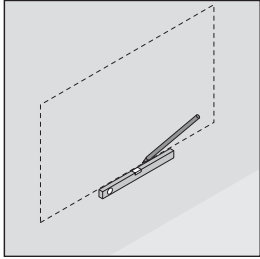

5

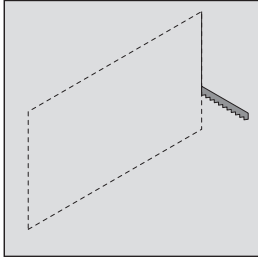

6

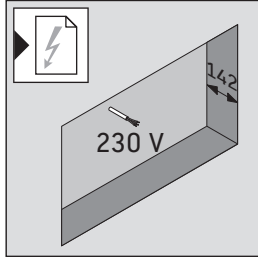

7

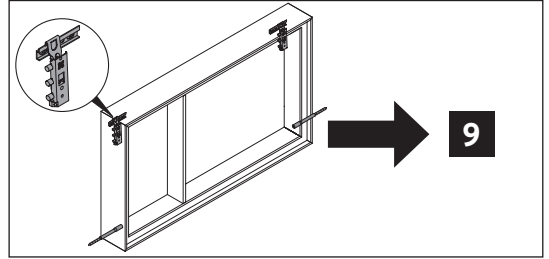

8

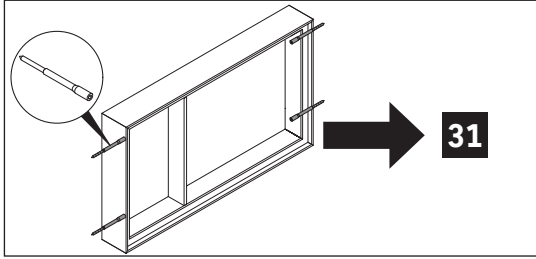

9

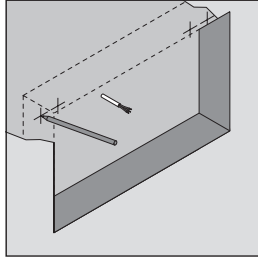

10

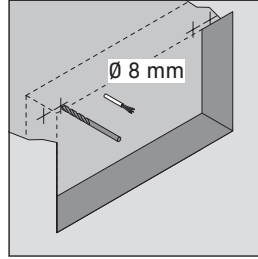

11

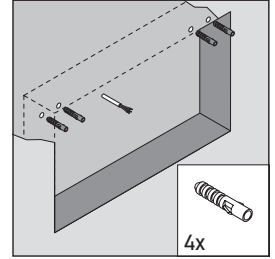

12

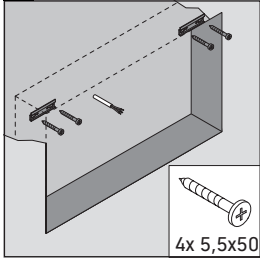

13

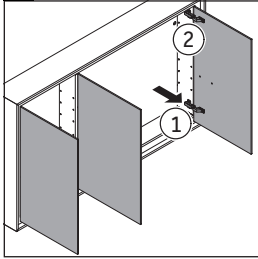

14

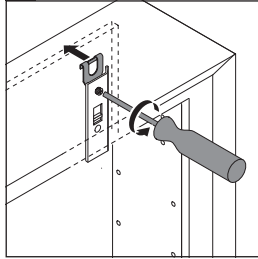

15

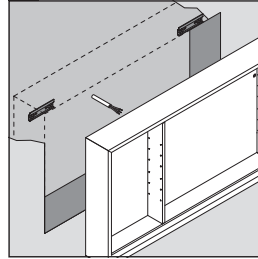

16

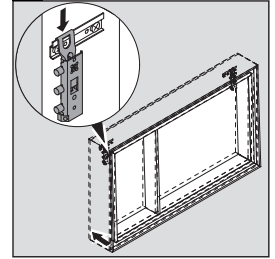

17

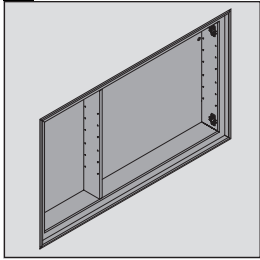

18

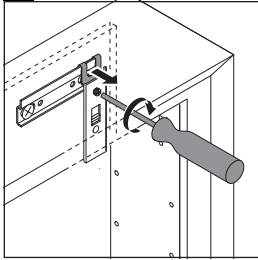

19

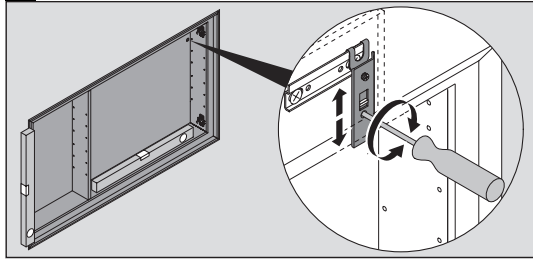

20

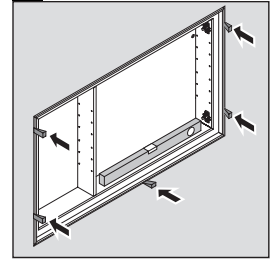

21

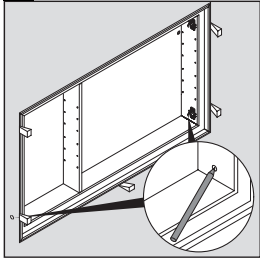

22

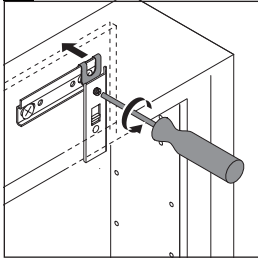

23

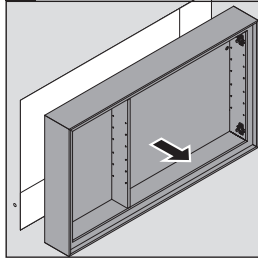

24

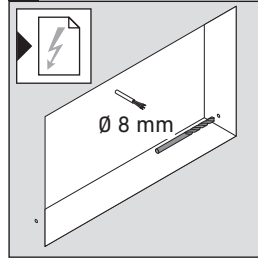

25

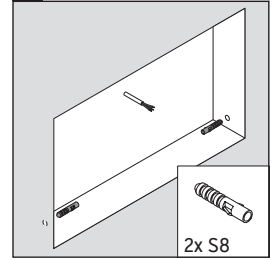

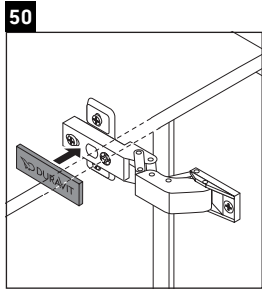
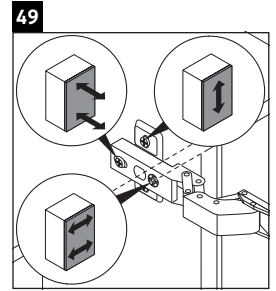
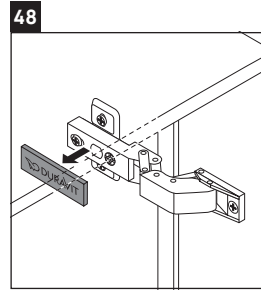
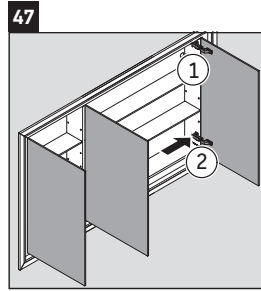
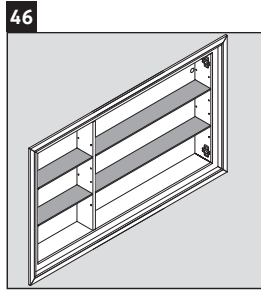
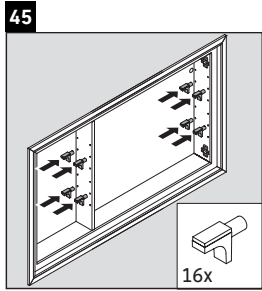
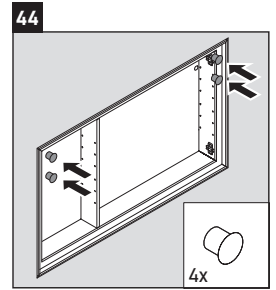
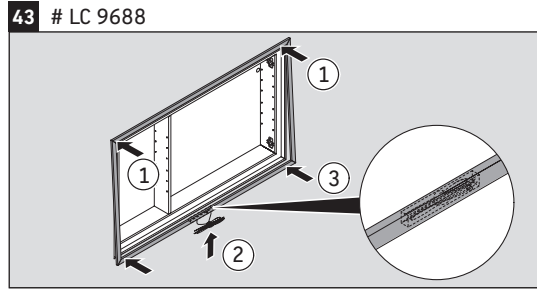
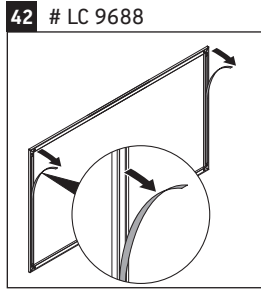
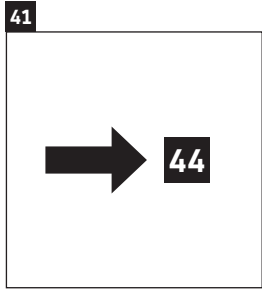
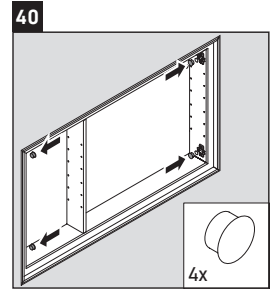
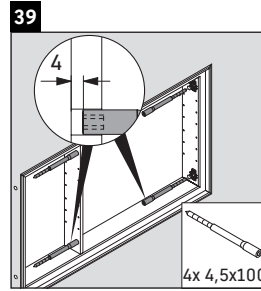
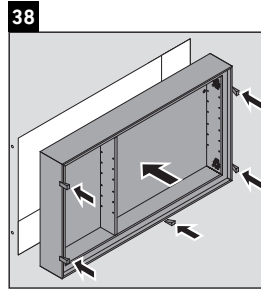
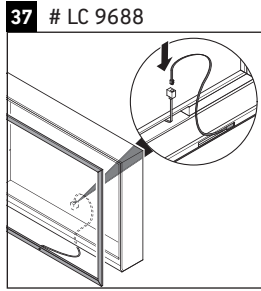
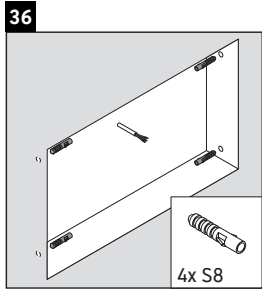
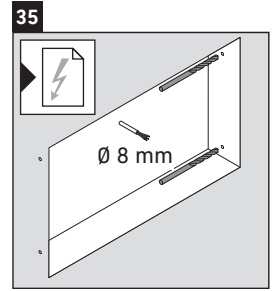
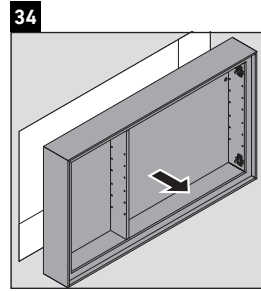
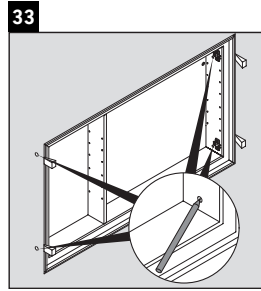
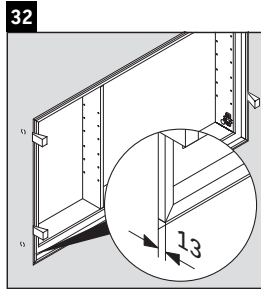
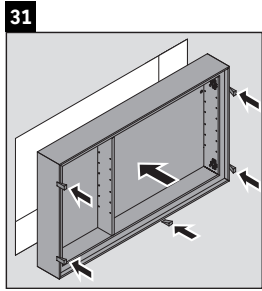
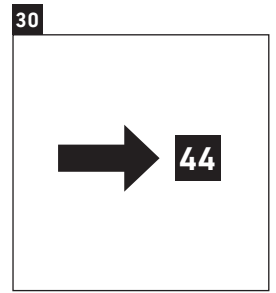
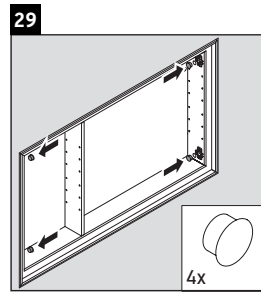
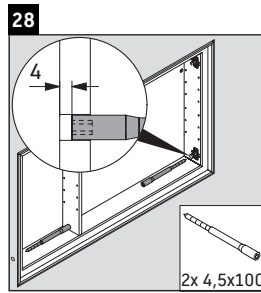
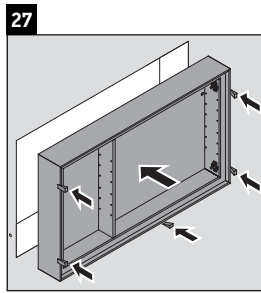
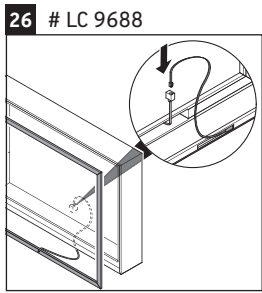

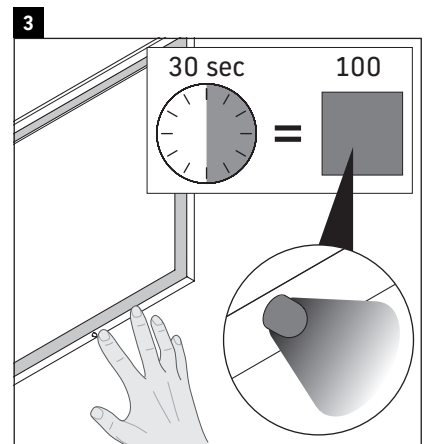
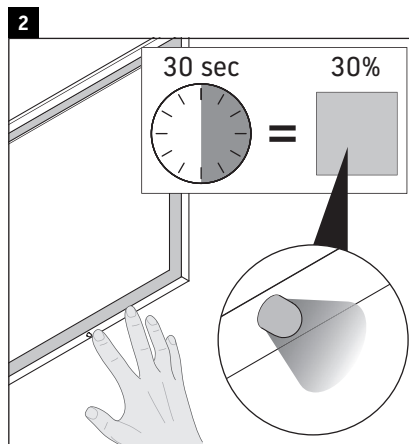
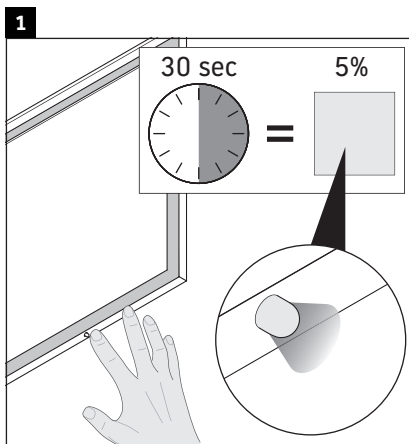
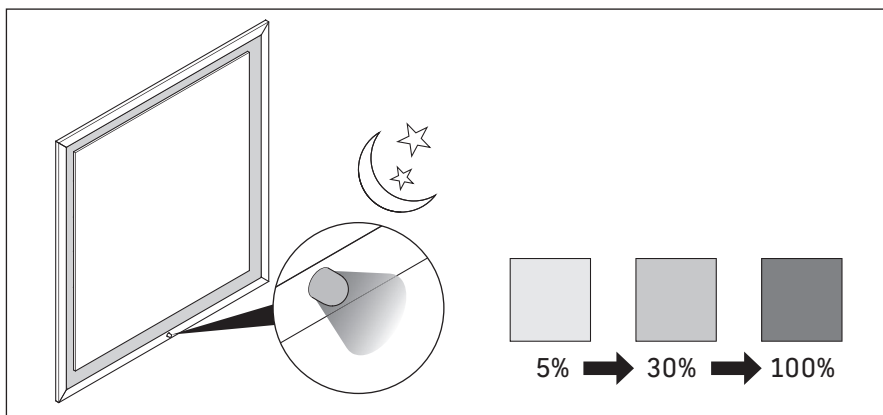
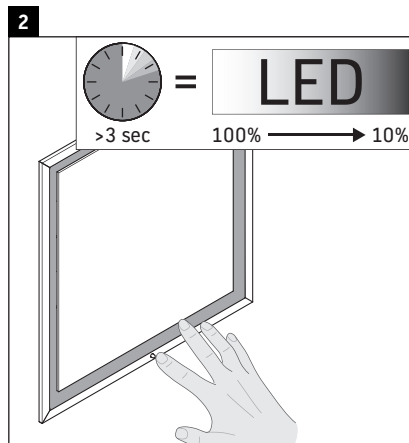
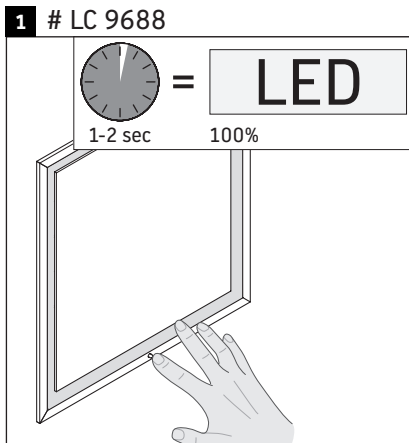

Montageanleitung für Badmöbel mit Stromführung



Sicherheit

2



Elektroinstallation

3



Sicherheit

Bestimmungsgemäße Verwendung

Die Montageanleitung ist Bestandteil des Duravit Produkts und richtet sich an Personen, die die Elektroinstallation für das Produkt durchführen. Die Montageanleitung muss sorgfältig gelesen werden und jederzeit verfügbar sein.

Zielgruppe und Qualifikation

Die Elektroinstallation darf nur von ausgebildeten Elektrofachkräften durchgeführt werden.

Schutzart von Duravit Produkten

Die Schutzart von stromführenden Duravit Produkten entspricht mindestens dem Standard IP 44.

Schutzklassen der Leuchten

Schutzklasse	Anschlussleitung
I	H05VV-F, 3x 1,5 qmm
II	H03VV-F, 2x 0,75 qmm

Richtlinien und Normen

Duravit Produkte entsprechen den Richtlinien der CE-Kennzeichnung:



Zeichen und Symbole

Symbol	Bedeutung
>	Handlung erforderlich

Entsorgung

- Produkt nicht im Hausmüll entsorgen. Produkte mit diesem Symbol sind gemäß WEEE-Richtlinie über die örtlichen Sammelstellen für Elektroaltgeräte zu entsorgen.



Sicherheitshinweise

Lebensgefahr

Der Kontakt mit Strom führt zu elektrischem Schlag.

- > Elektroinstallation gemäß nationaler, europäischer und internationaler Richtlinien und Normen durchführen.
- > Schutzzonen für Feuchträume gemäß länderspezifischer Normen, örtlichen Vorschriften und Niederspannungsrichtlinien einhalten.
- > Bei Feuchträumen oder sonstigen, speziell ausgewiesenen Räumlichkeiten den elektronischen Anschluss über einen GFI-Sicherungsautomaten durchführen.
- > Vor der Installation elektrische Komponenten vom Stromnetz trennen.
- > Prüfen, ob alle Komponenten spannungsfrei sind.
- > Verhindern, dass die Stromzufuhr versehentlich zugeschaltet wird.

Eindringen von Fremdkörpern und Wasser

Fremdkörper oder Wasser im Betriebsmittel führen zu einem Kurzschluss, der Produktschäden verursachen kann.

- > Die Schutzzonen für Duravit Produkte beachten.

Schutzzonen

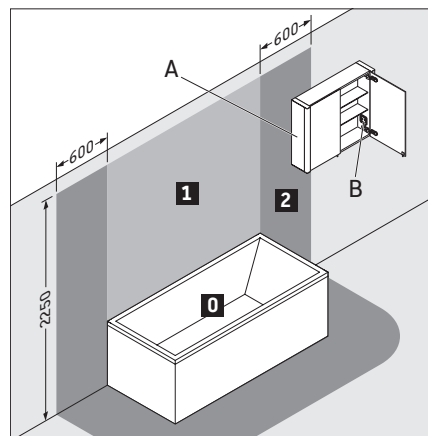

A Spiegelschrank mit IP 44 darf in Zone 2 hineinragen.

B Eine im Spiegelschrank vorhandene Steckdose muss außerhalb der Zonen montiert sein.

Energieeffizienzklasse

- Dieses Produkt enthält eine Lichtquelle der Energieeffizienzklasse F.



Elektroinstallation für Schutzklasse I

Stromanschluss

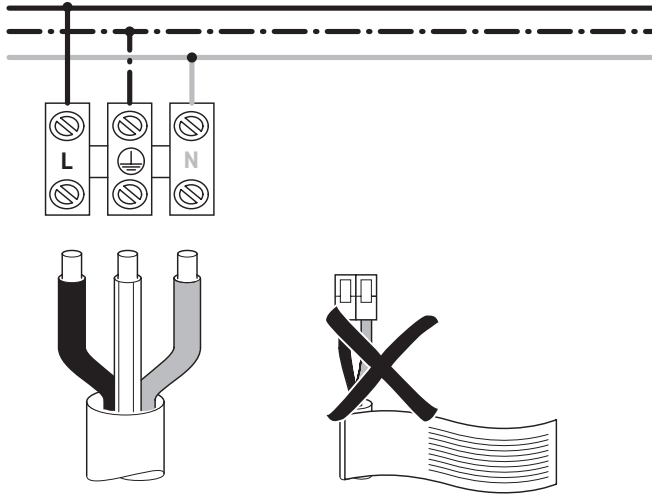

Optionaler Anschluss eines externen Tasters

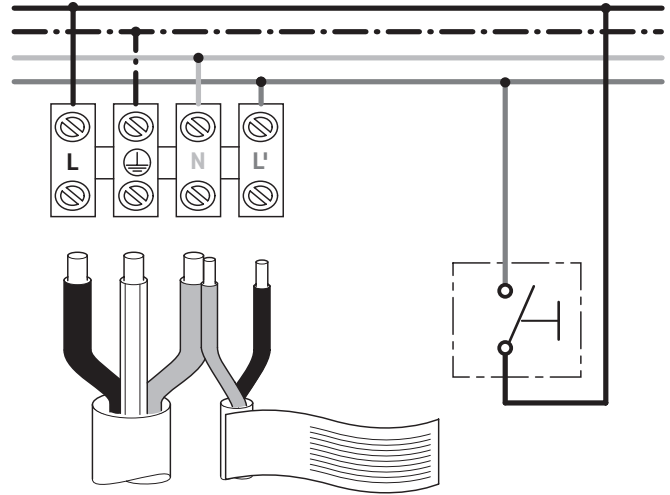

Elektroinstallation für Schutzklasse II

Stromanschluss

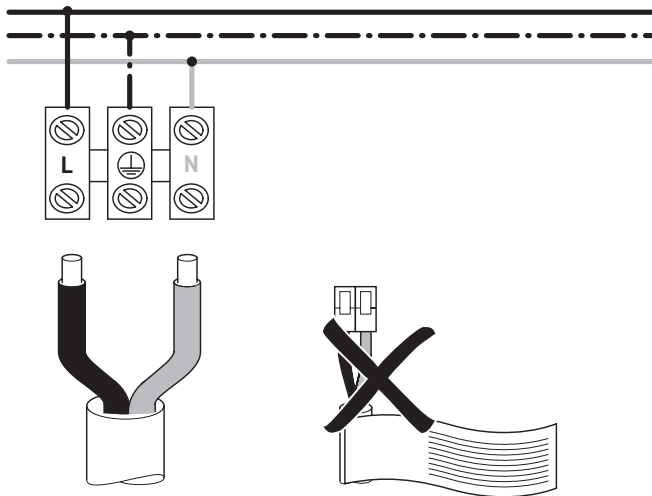

Optionaler Anschluss eines externen Tasters

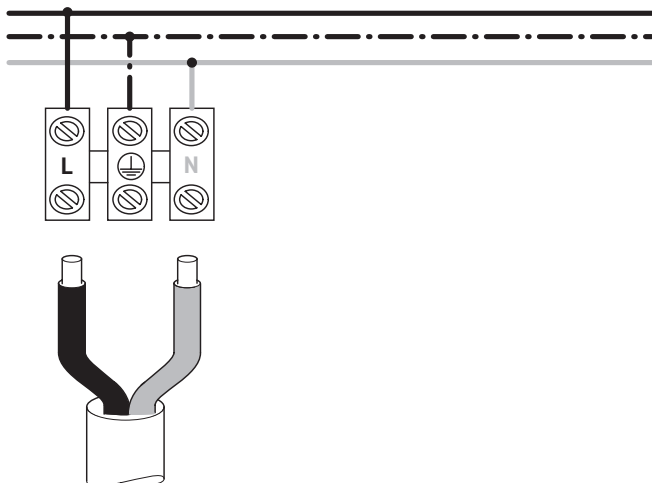
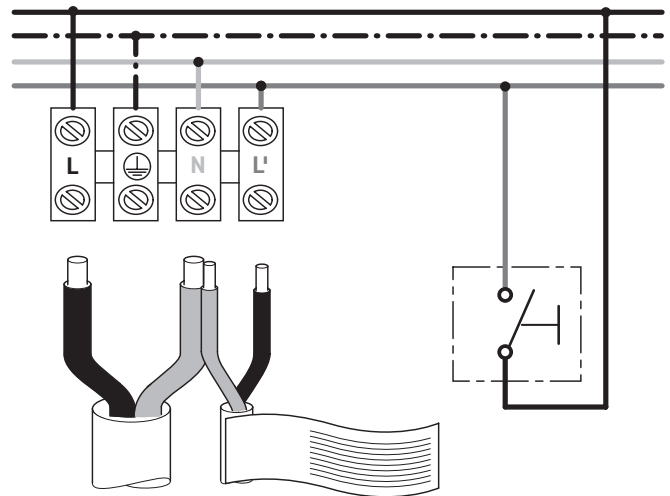

DURAVIT AG
P.O. Box 240
Werderstr. 36
78132 Hornberg
Germany
Phone +49 7833 70 0
Fax +49 7833 70 289
info@duravit.com
www.duravit.com

