

LANI Towel holder

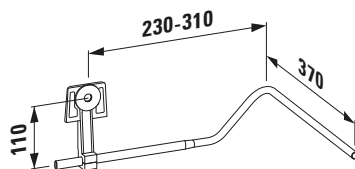

- DE** Garantie/Haftung nur bei Montage gemäss Anleitung.
FR Responsabilité/garantie à condition d'observer les instructions de montage.
IT Garanzia valida solo se si rispettano le istruzioni di montaggio
EN The warranty/liability only applies when installation is effected as per the instructions.
ES La garantía solamente será válida si se siguen las instrucciones de instalación.
NL Garantie/aansprakelijkheid uitsluitend van kracht indien volgens de instructies is geïnstalleerd.
CS Záruka a ručení za vady jsou poskytovány za podmínky, že montáž je provedena v souladu s tímto návodem.
LT Garantija taikoma tik tuo atveju, kai montavimas yra atliktas tiksliai pagal instrukciją.
PL Gwarancja obejmuje wyrób jedynie wówczas gdy montaż został przeprowadzony zgodnie z instrukcją.
HU Szavatosság/jótállás csak az útmutató szerinti szerelés esetén.
RU Мы предоставляем гарантию и несем ответственность, только если монтаж произведен в соответствии с инструкцией по монтажу.
BG Гаранцията/отговорността е валидна само когато монтажът е изпълнен както е указано в инструкцията.
PT Garantia/responsabilidade apenas no caso de montagem de acordo com as instruções.
SK Záruka platí, len ak sa montáž vykoná podľa návodu
HR Jamstvo vrijedi samo ako je montažu izvršilo ovlašteno prema uputama.
DA Garantien gælder kun, hvis monteringen udføres af en autoriseret fagmand, der følger vejledningen.
ET Garantii/vastutus kehtib ainult paigaldusloaga spetsialisti tehtud juhendile vastava paigalduse korral.
FI Takuu/tuotevastuu vain, kun asennuksen käyttööheeen mukaisesti.
LV Garantija ir spēkā tikai tad, ja uzstādīšanu saskaņā ar instrukcijām.
NO Garanti/erstatningsansvar kun hvis monteringen er utført av i henhold til veiledning.
RO Garanția este valabilă doar în cazul montării conforme cu instrucțiunile.
SV Garanti/ersättningskyldighet gäller endast om monteringen har genomförts enligt anvisningen.
SL Garancija oz. jamstvo velja le, če je montažo izvedel strokovnjak s koncesijo v skladu z lokalnimi predpisi.



Art. No.: 3.8212.0

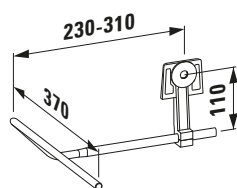

Art. No.: 3.8212.1

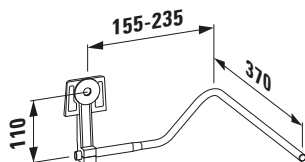

Art. No.: 3.8212.2

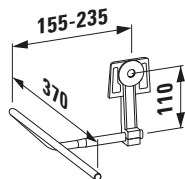

Art. No.: 3.8212.3

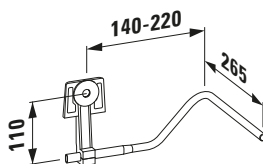

Art. No.: 3.8212.4

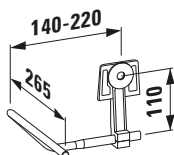

Art. No.: 3.8212.5

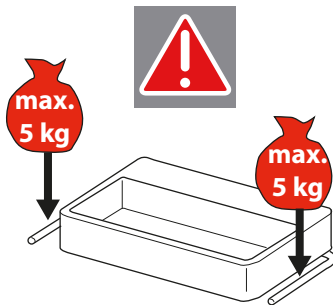
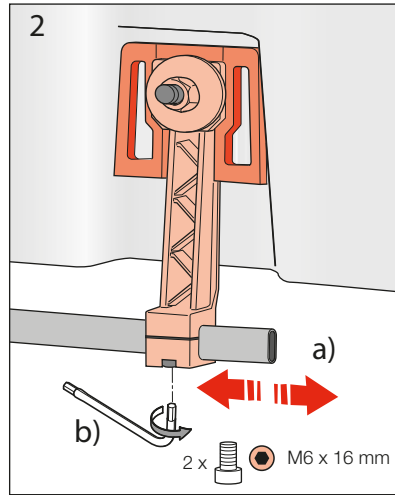
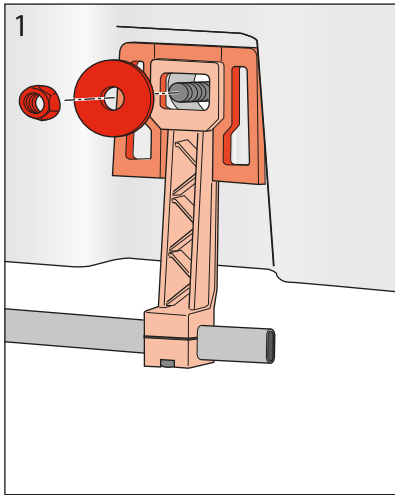
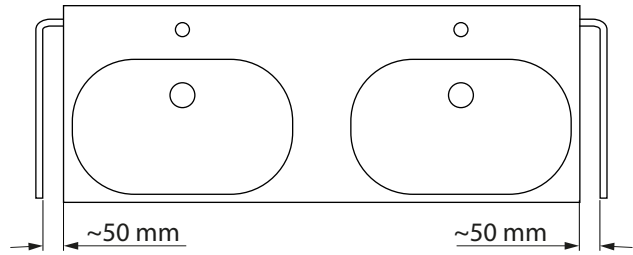
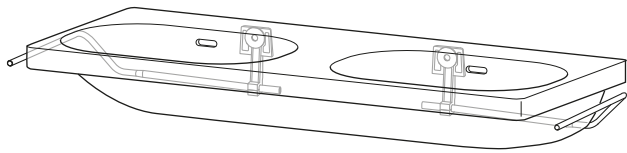

LAUFEN

Laufen Bathrooms AG
Wahlenstrasse 46
CH-4242 Laufen, Switzerland
www.laufen.com

