















83 210 892 Produktversion ab 01.04.2024



- Breite 90 mm
- Höhe 55 mm
- Rosette Ø 55 mm
- Ausladung 460 mm

| | | |
|---|---------------------------------|---------------|
|  | Bronze gebürstet | 83 210 892-42 |
|  | Chrom | 83 210 892-00 |
|  | Platin gebürstet | 83 210 892-06 |
|  | Platin | 83 210 892-08 |
|  | Weiß matt | 83 210 892-10 |
|  | Dark Brass matt | 83 210 892-16 |
|  | Dark Bronze matt | 83 210 892-17 |
|  | Dark Chrome | 83 210 892-19 |
|  | Light Gold gebürstet | 83 210 892-27 |
|  | Messing gebürstet (23kt Gold) | 83 210 892-28 |
|  | Schwarz matt | 83 210 892-33 |
|  | Champagne gebürstet (22kt Gold) | 83 210 892-46 |
|  | Champagne (22kt Gold) | 83 210 892-47 |
|  | Chrom gebürstet | 83 210 892-93 |
|  | Dark Platin gebürstet | 83 210 892-99 |

83 210 892 Produktversion ab 01.04.2024

mm [inches]

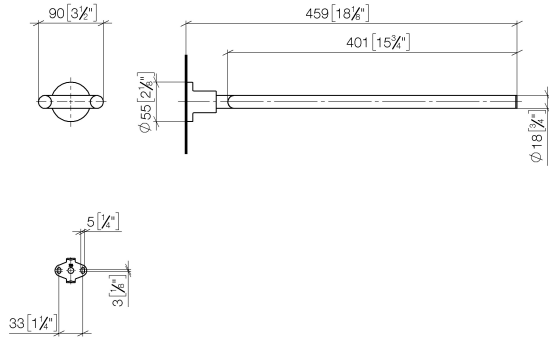

83 210 892 Produktversion ab 01.04.2024

Ersatzteile für die
anderen
Oberflächenvarianten
finden Sie hier:
Chrom

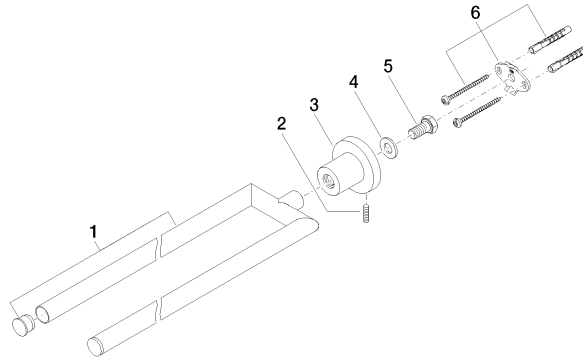

Ersatzteilstückliste

| Nr. | Artikelnummer | Benennung | Verbaumenge | Lieferzeit |
|-----|--------------------|---|-------------|------------|
| 4 | 09 30 11 046 90 | Unterlegscheibe Ø 10,5 - | 1,00 | 2 |
| 6 | 05 17 20 739 00 90 | Befestigungssatz 150 x 65 x 10 mm - | 1,00 | 2 |
| 2 | 04 31 11 113 00 90 | Befestigung Gewindestift M5 x 12 mm - | 1,00 | 2 |
| 3 | 08 17 89 505-42 | Halter universal 60 x 100 x 60 mm - Bronze gebürstet | 1,00 | 60 |
| 1 | 90 17 89 554 00-42 | Halter für Handtuchhalter doppelt 92 x 21,5 x 419 mm - Bronze gebürstet | 1,00 | 30 |
| 5 | 09 30 30 071 90 | Befestigung Sechskantschraube mit Gewinde bis Kopf M10 x 20 mm - | 1,00 | 2 |