

Technische Daten/ Technical Data

KLUDI ZENTA SL

electronic controlled basin mixer
trim set
240 mm

Ref.: 3840005

Finishes:
05 chrome

Product description

Manufacturer KLUDI GmbH & Co. KG

Typ: KLUDI ZENTA SL

electronic controlled basin mixer

Ref.: 3840005

electronic controlled basin mixer
6V battery or 230V main adapter
trim set without pre-installation set
pre installation set KLUDI Art. Nr. 38001 and 38002
mixing shaft with temperature handle
optical object registration
aerator, S-Pointer M24 PCA
flow rate at 3 bar 5 l/min.
activation optoelectrical
maximum water run-time ca. 2 minutes
safety class IP65
hygienic flushing

Produktabbildung/ Product picture



Maßzeichnung/ Dimensional drawing

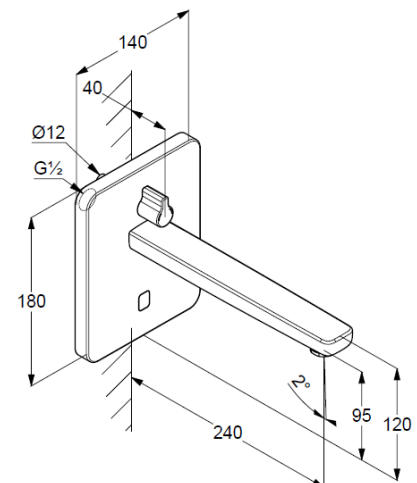

Durchfluss/ Flow rate

