

CL.1 UP-Zweiwege-Umstellung - Chrom

CL.1







36 202 705



- Drehumstellung
- Rosette 60 x 60 mm

Passt zu CL.1

Passt zu CL.1

	Chrom	36 202 705-00
	Platin gebürstet	36 202 705-06
	Dark Chrome	36 202 705-19
	Champagne gebürstet (22kt Gold)	36 202 705-46
	Champagne (22kt Gold)	36 202 705-47
	Dark Platinum gebürstet	36 202 705-99

Benötigtes Zubehör



- UP-Zweiwege-Umstellung -** 35 202 970 90
- Max. Einbautiefe 160 mm
 - Min. Einbautiefe 115 mm

36 202 705

mm [inches]

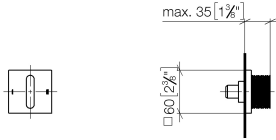

Durchflussdiagramm

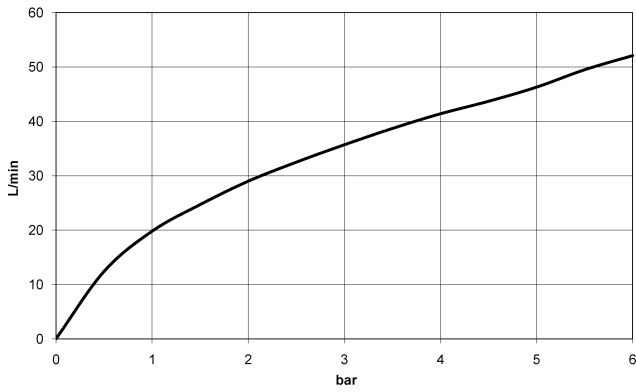

Codes & Standards

DIN 4109

ISO 3822

Scottish Water
Byelaws

UK Water Supply
Regulations

Ü-Zeichen



CL.1 UP-Zweiwege-Umstellung - Chrom

CL.1

36 202 705

Zertifikate

WRAS_2307

LGA_38

36 202 705

Produktversion ab 4/1/2022

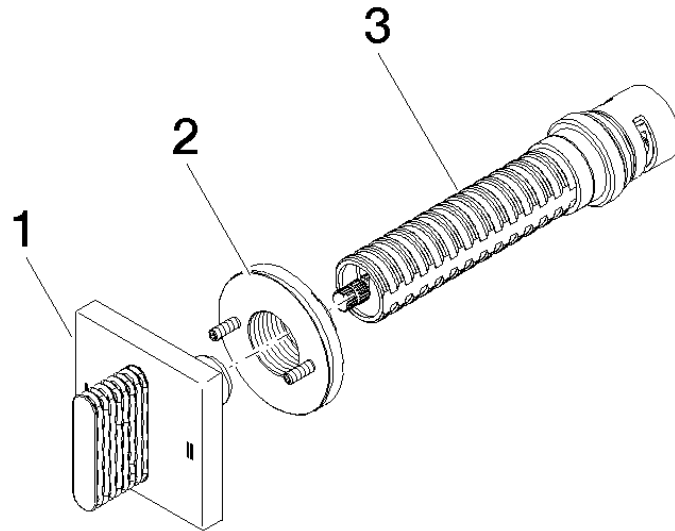



CL.1 UP-Zweiwege-Umstellung - Chrom

CL.1

36 202 705

Ersatzteilstückliste

Produktversion ab 4/1/2022

Nr.	Artikelnummer	Benennung	Verbaumenge	Lieferzeit
	90 20 70 053 08-00	Griff - Chrom	3	10