









36 503 892



- Abdeckplatte Ø 123 mm
- Skalengriff mit Sicherheitssperre bei 38°C
- Thermostat-Kartusche

	Chrom	36 503 892-00
	Platin gebürstet	36 503 892-06
	Platin	36 503 892-08
	Dark Chrome	36 503 892-19
	Light Gold gebürstet	36 503 892-27
	Messing gebürstet (23kt Gold)	36 503 892-28
	Schwarz matt	36 503 892-33
	Bronze gebürstet	36 503 892-42
	Champagne gebürstet (22kt Gold)	36 503 892-46
	Champagne (22kt Gold)	36 503 892-47
	Chrom gebürstet	36 503 892-93
	Dark Platinum gebürstet	36 503 892-99

Benötigtes Zubehör



xTOOL UP-Thermostatmodul ohne Mengenregulierung - 35 503 970 90
 •Max. Einbautiefe 160 mm
 •Min. Einbautiefe 95 mm

Empfohlenes Zubehör



xGRID Befestigungssatz für die Integration in den Trockenbau - 12 340 970 90

Benötigtes Zubehör



xGRID Montageschiene 555 mm - 12 360 970 90

36 503 892

mm [inches]

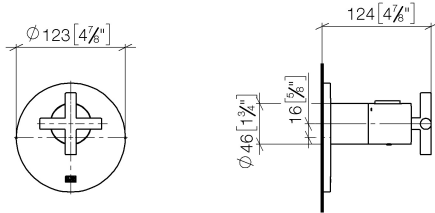

Durchflussdiagramm

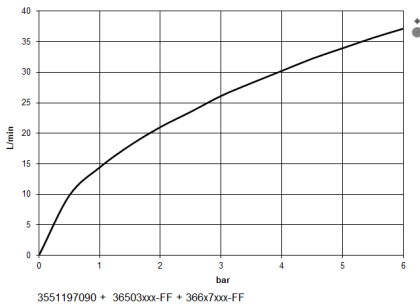

Codes & Standards

DIN 4109

ISO 3822

Scottish Water
Byelaws

UK Water Supply
Regulations

Ü-Zeichen



TARA xTOOL UP-Thermostat ohne Mengenregulierung 3/4" - Chrom

TARA

36 503 892

Zertifikate

LGA_29

LGA_29

LGA_29

WRAS_2011

36 503 892

Produktversion ab 5/1/2022

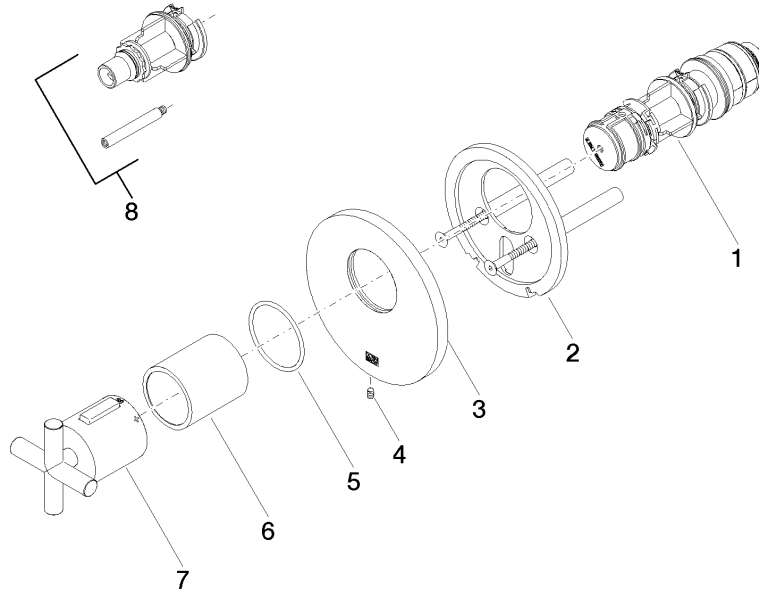



TARA xTOOL UP-Thermostat ohne Mengenregulierung 3/4" - Chrom

TARA

36 503 892

Ersatzteilstückliste

Produktversion ab 5/1/2022

Nr.	Artikelnummer	Benennung	Verbaumenge	Lieferzeit
	90 15 02 065 00 90	Thermostatkartusche mit Reglereinheit Ø 44 x 147 mm, 50 l/min. -	8	2